

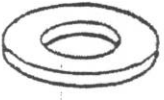



LIST OF PARTS

A	B	C	D	E	F	G
FLAT WASHER	LOCK WASHER	NUT	KD. BOLT (LONG)	KD. BOLT (SHORT)	WOOD SCREW	KEY WRENCH
10 PCS.	10 PCS	4 PCS.	4 PCS.	2 PCS.	6 PCS.	1 PC.
						

STEP 1 : PLACE THE SEAT FRAME ON THE BACK FRAME AND INSERT A FLAT WASHER (A), LOCK WASHER (B) AND A SHORT BOLT (E) INTO EACH OF THE 2 HOLES ON THE BACK OF THE SEAT, TIGHTEN THE BOLT WITH THE KEY WRENCH (G) BY TURNING CLOCKWISE UNTIL SECURE. (SEE DETAIL : A), INSERT THE FLAT WASHER (A), LOCK WASHER (B) AND LONG BOLT (D) INTO EACH OF THE 2 HOLES IN THE SEAT CORNERS, TIGHTEN THE BOLT WITH THE KEY WRENCH (G) BY TURNING CLOCKWISE UNTIL SECURE. (SEE DETAIL : A)

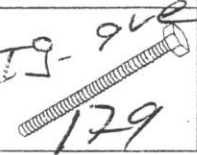
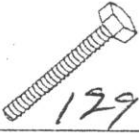

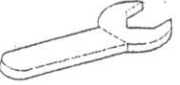
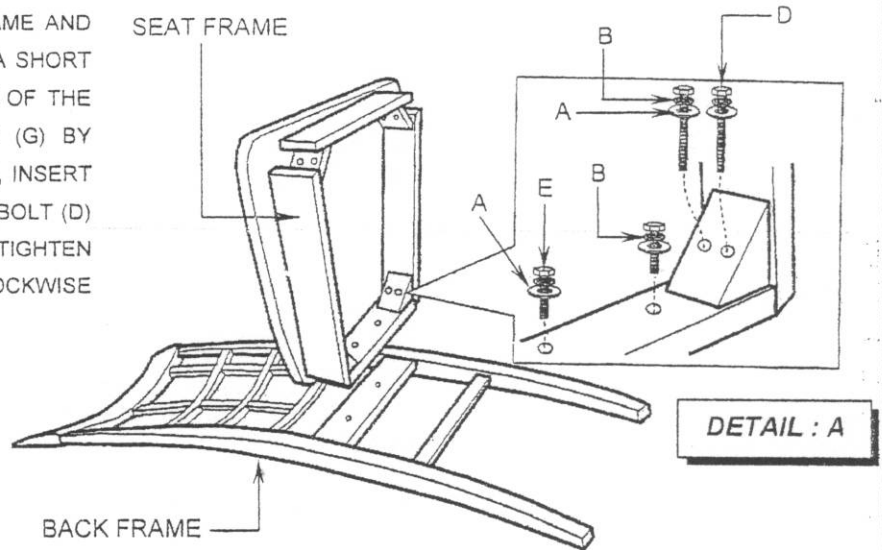
STEP 2 : ATTACH RIGHT AND LEFT FRONT LEG TO THE FRONT OF THE SEAT FRAME. PLACE FLAT WASHER (A) , LOCK WASHER (B) AND NUT (C) ON EACH BOLT. TURN THE NUT ON EACH BOLT SEVERAL TURNS WITH KEY WRENCH (G) BUT DO NOT TIGHTEN YET. (SEE DETAIL : B) INSERT 2 SIDE STRETCHERS AND FRONT STRETCHER INTO THE HOLES BETWEEN FRONT AND BACK LEG AND FASTEN WITH WOOD SCREWS (F) ON EACH USING PHILIPS HEAD SCREWDRIVER (NOT PROVIDED). TIGHTEN ALL BOLTS BEFORE USING CHAIR.

