

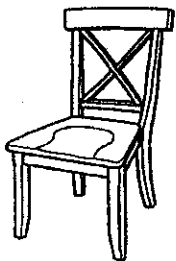





# LIGO PRODUCTS

## Mokena - Illinois

# ASSEMBLY INSTRUCTIONS

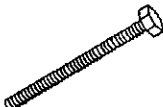
## RCH-408

A	B	C	D	E	F	
FLAT WASHER 11 PCS.	LOCK WASHER 11 PCS	NUT 4 PCS.	KD. BOLT (LONG) 4 PCS.	KD. BOLT (SHORT) 3 PCS.	KEY WRENCH 1 PC.	
						

**STEP 1 :** PLACE THE SEAT FRAME ON THE BACK FRAME AND INSERT A FLAT WASHER (A), LOCK WASHER (B) AND A SHORT BOLT (E) INTO EACH OF THE 3 HOLES ON THE BACK OF THE SEAT (SEE DETAIL : A ) TIGHTEN THE BOLT WITH THE KEY WRENCH (F) BY TURNING CLOCKWISE UNTIL SECURE. INSERT THE FLAT WASHER (A), LOCK WASHER (B) AND LONG BOLT (D) INTO EACH OF THE 2 HOLES IN THE SEAT CORNERS, TIGHTEN THE BOLT WITH THE KEY WRENCH PROVIDED (F) BY TURNING CLOCKWISE UNTIL SECURE.

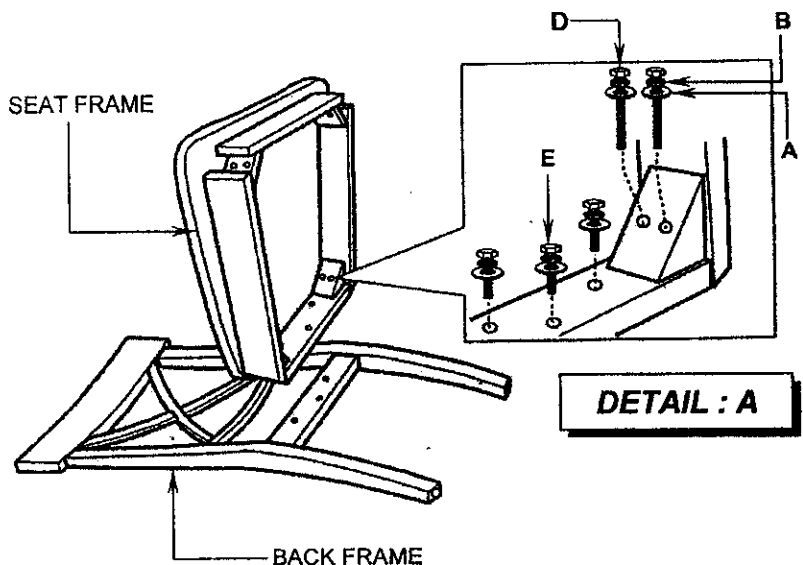

**STEP 2 :** ATTACH FRONT LEGS TO THE CORNERS OF SEAT BOX. PLACE A FLAT WASHER (A), LOCK WASHER (B) AND NUT (C) ON EACH BOLT (SEE DETAIL : B). TURN THE NUT ON EACH BOLT SEVERAL TURNS WITH THE KEY WRENCH (F) PROVIDED. **BUT DO NOT TIGHTEN YET.** TURN THE CHAIR UPRIGHT AND LEVEL THE CHAIR BY PRESSING DOWN ON THE SEAT. SECURELY TIGHTEN ALL NUTS AND BOLTS WITH THE KEY WRENCH (F) PROVIDED (SEE DETAIL: B).

